

9.

Hikmah_2020_J._Phys._Conf._S
er._1569_022014.pdf

by

Submission date: 22-Mar-2023 09:12AM (UTC+0700)

Submission ID: 2043174830

File name: 9. Hikmah_2020_J._Phys._Conf._Ser._1569_022014.pdf (473.34K)

Word count: 4146

Character count: 22515

PAPER · OPEN ACCESS

Information System Design of Web-Based Integrated Surveillance of Ari Disease in The Health Office

To cite this article: Faiqatul Hikmah *et al* 2020 *J. Phys.: Conf. Ser.* **1569** 022014

View the [article online](#) for updates and enhancements.

You may also like

- [Reproducibility of dynamic cerebral autoregulation parameters: a multi-centre, multi-method study](#)
Marit L Sanders, Jurgen A H R Claassen, Marcel Aries et al.
- [The Additional Representative Images for Legacy \(AR-L\) Project for the ALMA Science Archive](#)
M. Massardi, F. Stoehr, G. J. Bendo et al.
- [COHmax: an algorithm to maximise coherence in estimates of dynamic cerebral autoregulation](#)
Ronney B Panerai, Kannakorn Intharakham, Jatinder S Minhas et al.

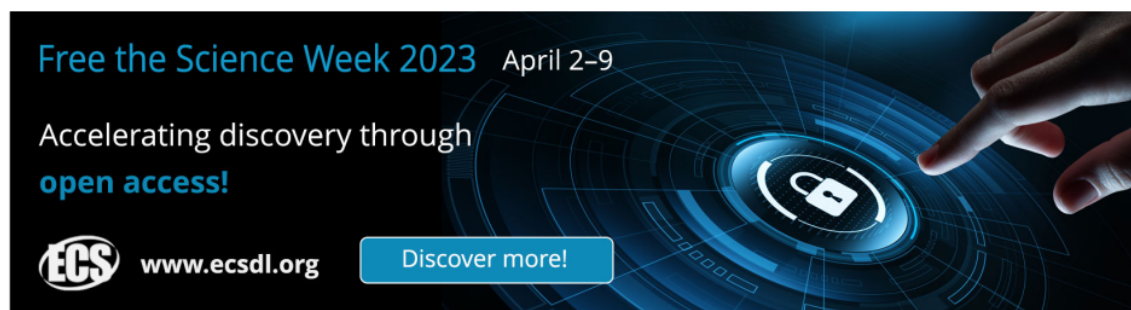

Free the Science Week 2023 April 2-9

Accelerating discovery through
open access!

 www.ecsdl.org [Discover more!](#)

The banner features a dark blue background with a futuristic, glowing interface. A hand is shown interacting with a circular element that contains a white padlock icon, symbolizing open access. The text is in white and light blue, with the ECS logo and website URL in white.

Information System Design of Web-Based Integrated Surveillance of Ari Disease in The Health Office

Faiqatul Hikmah¹⁾, Sustin Farlinda²⁾, Mochammad Choirur Roziqin³⁾, Zhindy Faris⁴⁾
¹ Department of Health, Politeknik Negeri Jember

faiqatul@polije.ac.id¹⁾, sustin@polije.ac.id¹⁾, irul@polije.ac.id¹⁾

Abstract. Integrated surveillance of ARI disease at Health Office of Jember is still using manual method in reporting in which the officers have to come directly to the Health Office to collect the data. The problem emerged of this manual method is the difficulty of designing the report because the officers have to recap and re-search the data of the report, and the data collection process is often late due to the far distance of the health center to the manual health office. This research was intended to create a design for data recording and reporting system of integrated surveillance of ARI disease in order to facilitate the reporting process to the Health Office. The method used was waterfall method with the stages of need identification, designing system, Website implementation, integration, and testing. This research used qualitative approach, in which the data were collected through the interview, observation, and FGD. The script editors used were PHP program and Sublime Text3. The result obtained from this research was the information system of integrated surveillance report of ARI disease. Thus, it is suggested to increase the distribution of component data related to the integrated surveillance report in order to decide the action planning of ARI disease.

1. Introduction

Infectious diseases still become a major health problem for Indonesian people, besides the increasing problem of non-communicable diseases. The infectious diseases do not recognize the administrative boundaries, so that the eradication of infectious diseases needs the cooperation between regions, such as between provinces, districts/regencies, or even countries.

In 1987, Data-Based Integrated Surveillance System or *Sistem Surveilans Terpadu (SST)*, Health Center Integrated Reporting System or *Sistem Pencatatan Pelaporan Terpadu Puskesmas (SP2TP)* had been developed. Besides SST, a number of surveillance systems for tuberculosis, malaria, dengue fever, leprosy, and so on had also been developed. The surveillance systems need to be developed and adjusted to the Provisions of Law Number 22 of 2009 concerning about Regional Government; Law Number 25 of 1999 about Financial Balance between Central and Regional Governments; Government Regulation Number 25 of 2000 concerning Government Authority and Province's Authority as Autonomous Regions, and Minister of Health Decree Number 1116/MENKES/SK/VIII/2003 concerning Guidelines for Implementing the Health Epidemiology Surveillance System as well as the need for epidemiology information to support the eradication of infectious diseases and non-communicable diseases.

Epidemiology of Integrated Infectious Diseases and Non-Communicable Diseases are also called as Integrated Surveillance Diseases or *Surveilans Terpadu Penyakit (STP)*. The implementation of integrated epidemiological surveillance is taken from the data of the Health Center, Hospital, Laboratory, and District/City Health Office.

Hospital and Health Center are health service providers for the society in which the patients get the health service they need covering promotive, preventive, curative, and rehabilitative services (Ministry of Health, 1998). Besides, hospital is the data provider which is used in the implementation of



Content from this work may be used under the terms of the [Creative Commons Attribution 3.0 licence](https://creativecommons.org/licenses/by/3.0/). Any further distribution of this work must maintain attribution to the author(s) and the title of the work, journal citation and DOI.

Surveillance System. Health Epidemiology and the need of epidemiology information to support the eradication of infectious diseases and non-communicable diseases. Hospitals must administer STP or Integrated Surveillance Diseases. Through STP, hospitals are able to report all the activities' results to the next level according to the needs correctly, periodically, and regularly to support the management of public health effort.

Acute Respiratory Infection (ARI) is a respiratory infection caused by a virus or bacteria and lasts for 14 days. ARI is an acute infection disease which attacks the upper and lower of respiratory tracts. ARI can cause mild symptoms (cough, flue), moderate symptoms (shortness of breath, wheezing) until severe symptoms (cyanosis, nasal lobe breathing). The severe ARI which attacks lungs tissue can cause pneumonia. Pneumonia is an infection disease which becomes the number one cause of death in children under five years old (Balitbang Riskesdas, 2013).

Generally, children experience ARI more often either in the developing countries or in the developed countries. ARI occurrence is more common in the developing countries. Every year, ARI causes 4 out of 15 million estimated deaths in the under-five children and as many as two third of deaths are infants (WHO, 2003). The most cases happened in India (43 million), China (21 million), Pakistan (10 million), and Bangladesh, Indonesia, Nigeria are 6 million cases of each (Rudan et al Bulletin WHO, 2008).

The prevalence of ARI in Indonesia according to the diagnosis of health personnel and public complaints in 2013 was 25.0%. The five provinces with the highest ARI were East Nusa Tenggara (41.7%), Papua (31.1%), Aceh (30.0%), West Nusa Tenggara (28.3%), and East Java (28.3%).

Based on the results of East Java Province Health Office in 2013, the number of ARI patients in East Java was 31.81%. Jember Regency is one of the areas in East Java with the high prevalence of ARI (Profile of the Jember Health Office, 2010). Based on the annual year report of Jember Regency Health Office, ARI was the most common disease suffered by people in Jember. ARI cases in Jember was at the top of the disease types which most attacked Jember society in 2013, as many as 137,752 cases, in 2014, it increased became 119,288 cases, and in 2015 decreased became 110,064 cases.

Based on the research conducted in Jember Regency, the result was SEIRS epidemic model for the spread of ARI, that every ARI patient could transmit the disease to more than one new patients or susceptible individual, so that in the following time, the disease spread more widely with more patients (Rupi Mitayani, 2014).

Recently, the integrated surveillance of ARI disease is still using manual method in which the officers have to come directly to the Health Office to collect the data. The problem emerged of this manual method is the difficulty of designing the report because the officers have to recap and re-search the data of the report, and the data collection process is often late due to the far distance of the health center to the manual health office, besides many officers leave their reports to other officers so that the reports are tucked or lost. Those factors cause the less effectiveness of reporting the disease data. The lack of data and fast information cause the programs made by the Health Service late. Fast and accurate information is needed, so that the Health Service or policy makers or stakeholders can immediately solve the problems that occur in the field.

To overcome the problems, an information system design research was conducted to accelerate the reporting process of integrated surveillance of ARI disease, can be solved by utilizing information technology in the form of web-based information system.

Based on the description in the background above, the main problem to be answered in this research was formulated as follows: "How to design a Web-Based Integrated Surveillance of ARI Disease at the Health Office of Jember in 2016?"

a. General Objective

The general objective of this research was to design a web-based integrated surveillance of ARI disease at the Health Office of Jember in 2017.

2. Literature Review

a. Research Location and Design

This research was conducted at the Health Office of Jember. This research is a qualitative research.

b. Research Instrument

Research instruments used in this research were observation guidelines, interview guidelines, FGD, recording devices, and stationery.

c. Research Variable

The data collection method used in this research were observation, interview, and FGD. The data analysis technique in this research was by describing the data obtained from the interview, observation, and FGD.

3. Working Methodology

a. The need analysis of Information System of Surveillance ARI Disease Report

The first stage done in designing the information system of integrated surveillance of ARI disease was a need analysis. In this stage, the researcher did the observation and interview to explore more information related to the system needs

The interview and observation directly to the P2KL Health Office. The interview was done to the head of P2KL and surveillance officers totaling 2 (two) people. In the observation result obtained an overview of the existing report of the integrated surveillance of ARI disease.

The reporting process was still manual that was by reporting the data directly by delivering it to the health office. The efforts that had been done to overcome the weakness of reporting data manually was by using e-mail other than direct reporting and still used the Excel application to process the data. However, even though email was used, still there was a re-recap process that needed more time.

b. The Information System Design of Web-Based Integrated Surveillance of ARI Disease

The software design of integrated surveillance of ARI disease reporting website, the researchers designed according to the need analysis. Based on the interview result, it was obtained the flow of integrated surveillance reporting system.

The stage of software designing formed a system based on the predetermined requirements, also identified and described the basic abstraction of software system and its relationships (Sommerville, 2011).

Based on the explanations above, the researchers designed website design by using flowchart, diagram context, data flow diagram (DFD), Entity Relationship Diagram (ERD) and database tables. A description of the website design as follows:

(a) C. Map Menu Design of Integrated Surveillance of ARI Disease Reporting Website

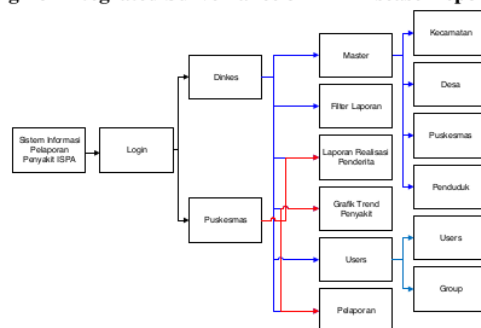

Figure 4.1 Map Menu of integrated surveillance of ARI disease

Based on the map menu system above, there was a log in page which could be accessed by the health office (blue arrow) and health center (red arrow). Administrator rights consisted of master data processing, reporting data, patient's realization report, filter report, disease trend chart, user and group. The master data that could be processed by the administrator were district, village, health center, and population data.

D. The Flowchart Design of Integrated Surveillance of ARI Disease Reporting Website

Flowchart system was a part that showed the overall flow of work in the system. This chart explained the order of procedures in the system. Here was the manual flowchart of the integrated surveillance report of ARI.

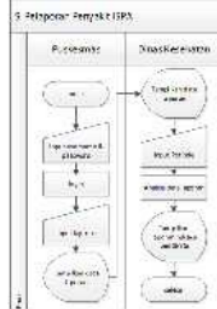

Figure 4.2 Manual Flowchart of the Integrated Surveillance Report of ARI Disease

The health center officer acted as user to do the login in the system by filling the username and password, if the username and password were correct, then the user could enter into the system. After entering the system, user could enter the data. The data which had been entered in the system produced the report display output that had been entered. The entry output then were processed became the patient's realization report that would be displayed to the Health Service (Administrator).

The following were the Admin and Health Center flowchart systems of the Integrated Surveillance Report of ARI Disease. Here was the administrator flowchart system (Health Office):

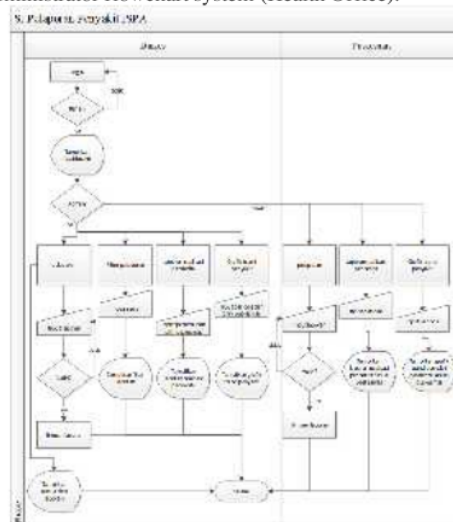

Figure 4.3 The Health Office and Health Center Flowchart Systems of Integrated Surveillance Report of ARI Disease

Diagram above was the administrator flowchart system from the information system reporting ARI disease. First, the user must login by entering username and password, if the login was successful, then it would enter into the dashboard page, but if the log in was failed, the user would remain in the log in page. The administrator had the access right to see the reports based on its periods and the chosen health center. Besides the health center officer, the administrator also had a right to enter the reports, this was intended if the health center officer could not enter the report then the administrator would be the one who entered the report. In the process of entering the report, there was a data validation to ensure the report entered was suitable with the applicable rules. Diagram above was the flowchart system of the health center officer. The diagram was almost similar with the administrator flowchart system but with the limited access. For reporting, the officer was only able to enter or see the report of people with ARI that were in the area of the health center.

E. Data Flow Diagram (DFD) of Integrated Surveillance of ARI Disease Reporting Website

Data Flow Diagram (DFD) is a graphical representation that describes the flow of information and transformations applied as flowing data. The following is the Diagram Context from integrated surveillance of ARI disease reporting website.

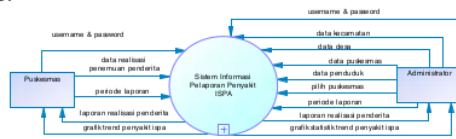

Figure 4.5 DFD Level 0 of Integrated Surveillance of ARI Disease Reporting Website.

In this DFD level 0, ARI disease reporting system that had been made, in concept can be seen in the picture above. Diagram context describes the data origin and shows the flow of the data. In the diagram context of ARI disease reporting system in the image, it consisted of 2 external entities that were administrator and health center. The flow of data that came out of each external entity meant that the data came from that external entity. While the incoming data flow meant that the data information was intended for that external entity. The diagram context above had a large process which was later decomposed into several more detailed processes.

The following is the Data Flow Diagram Level 1 from integrated surveillance of ARI disease reporting website.

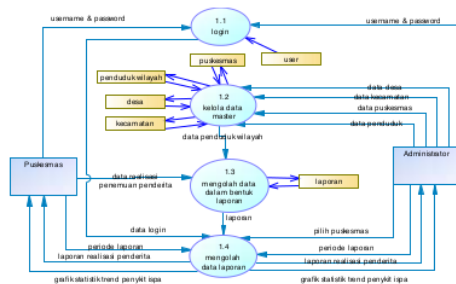

Figure 4.6 DFD level 1 of Integrated Surveillance of ARI Disease Reporting Website.

From the diagram context that had been made, it could be then divided into several processes as in the diagram above. These processes include the login process, master data processing, reporting, and report analysis process.

F. Entity Relation Diagram (ERD) of Integrated Surveillance of ARI Disease Reporting Website.

The following is the ERD of surveillance Diarrhea disease reporting website:

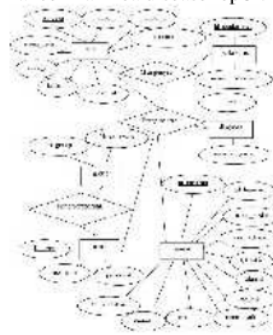

Figure 4.7 ERD of Integrated Surveillance of ARI Disease Reporting Website

G. Integrated Surveillance of ARI Disease Reporting Website Database

The next step was to create a database and create the tables needed for integrated surveillance of ARI disease reporting website. The database and tables creation used the Xampp PHPMyAdmin program. The researchers created a database named "db_ispa".

4. Experiment and Result

The implementation and testing of integrated surveillance of ARI disease reporting website, the researchers designed their own based on the needs analysis and continued with the Focuss Group Discuss (FGD) to get the final result. The Focuss Group Discuss (FGD) was done to the P2KL Health Office consisting of the head of P2KL and surveillance officers. The results of the FGD were obtained for the web-based design that the researchers had designed were indeed needed by the P2KL Health Office of Jember.

The menus on the website that the researchers had designed were in accordance with the needs of P2KL Health Office of Jember starting from the dashboard, reporting input data, Patient relization menu, and graphics.

At this stage, the software design was realized as a program unit, done by making program modules that were still stand-alone for each desired function. These modules were translated into computer or coding language using a web editor that was *dreamweaver SUBLIME TEXT3*. Then the syntax used in making this website were:

- 1) HTML5 used to write a website page
- 2) PHP used to make the website dynamic
- 3) MySQL used for the *database* interaction
- 4) *JavaScript*, Jquery, Ajax used so that the website was more interactive

After the coding stage was complete, testing would be done on the program modules that were still standing alone to verify that each unit met its specifications by using the tools that had been made.

In the implementation and testing stages of the system unit, the results of the software design will be realized as a set of programs or program units. Each unit will be tested whether or not it meets its specifications (Sommerville, 2011).

The researchers implemented integrated surveillance of ARI disease reporting website by giving display picture on the website. The explanation regarding the appearance of integrated surveillance of ARI disease reporting website as follows:

I. Login Display



Figure 4.8 Login Display

From figure 4.8, login display was a page used to access integrated surveillance of ARI disease reporting information system in Jember Helath Office. The login page for user and admin had the same look.

J. Incorrect Login Display



Figure 4.9 Failed Login Display

Figure 4.9 is a notification display where admin or user was wrong in entering a username and password.

K. Dashboard Display



Figure 4.9 Dashboard Display

Figure 4.9 is a display for admin or user of the front page or dashboard that contained information of the number of districts, villages, health centers, and website user. In addition there was also a display of the latest report containing the newly uploaded report.

L. Report Display



Figure 4.10 Report Display

Figure 4.10 is a display for filling in data, where the data was taken from integrated surveillance of ARI disease reporting form. The data was filled according to monthly data at the health center. The data inputted in the report was the patient's name, date of birth, gender, village, address, father's name, mother's name, telephone number, diagnosis, patient's condition, and date of death if the patient dies. In filling out there was a provision when filling in diagnoses, that were diagnosis of pneumonia, severe pneumonia, and non-Pneumonia cough, reported when the patient was only 0 to 4 years old. For the age of 5 years to the elderly the choice of diagnosis were only ARI Pneumonia and ARI non-Pneumonia. If there was an error when inputting, the data would not be saved or error. For the admin in the report menu, the facility were to delete, and edit data that had been sent by the Health Center. The date limit in surveillance reporting is every the 5th date.

M. Patient Realization Display



Figure 4.11 Patient Realization Display

Figure 4.11 is a display for admin or user. For user to see data that had been analyzed based on the desired period. The appeared data was data from all villages covered in one health center. The admin had a broader right that was had a menu to see all the data of all health centers in Jember Regency. The admin and user could exploit data into an excel file.

N. Graphic Display



Figure 4.12 Graphic Display

Figure 4.12 is a display to view data graphically. The data displayed in the form of the number of patients based on the diagnosis by going through the search filter stage using the year and month filters. This display applied to both admin and user, but for the admin, there was an additional menu to see all health centers graphics in all Jember regency.

O Report Filter Display



Figure 4.13 Report Filter Display

Figure 4.13 is a display only to Admin. In the Report Filter menu, it was used to help sorting the data from all health centers in Jember regency based on period, diagnosis, and age.

P. Master Menu Display



Figure 4.14 Master Menu Display

Figure 4.14 is a display on admin that functioned to add district master, health center, village, and addition of population projection. This menu was intended if one day experience changes.

Q. User Menu Display



Figure 4.15 User Menu Display

Figure 4.15 is a display on admin. The user menu consisted of user and groups, and this cannot be separated alone. Groups were grouping for multiple users. A user sub-module for user management that functioned to add user, change password, and username.

5. Conclusion

Based on the research results and discussion about “information system design of web-based integrated surveillance of ARI disease at the health office of Jember” could be gained conclusions as follows:

- a. The system needs analysis on ARI disease integrated surveillance report obtained name of districts in jember regency, name of district health centers, and form component of integrated surveillance of ARI disease report.

- b. The software design on integrated surveillance of ARI disease report was designed in accordance with the appearance of the website needed by the Health office. The design began with the manual flowchart, system flowchart, diagram context, Data Flow Diagram (DFD) Level 1, Entity Relation Diagram (ERD), and database.
- c. The system implementation resulted in an integrated surveillance of ARI disease reporting website that could be accessed by user and administrator. The implementation produced dashboard page, report, Realization of Patient, and statistic.
- d. The integration and test system produced an integrated surveillance of ARI disease reporting website that could be accessed offline via localhost. The result of testing the diarrhea surveillance reporting design system as a whole was successful and all existing functions could be run properly and correctly.

References

- [1] Abdul Kadir. 2009. Pengenalan Sistem Informasi. Yogyakarta: Andi.
- [2] Adinugroho Theo Wicaksono Sistem Pelaporan Terpadu Berbasis Web Pada Dinas Kesehatan). http://repository.amikom.ac.id/files/Publikasi_12.22.1439.pdf
- [3] Agushybana, farid. 2011. Sistem Informasi Surveilans Demam Berdarah Dengue (SIS DBD) Berbasis Web Untuk Perencanaan, Pencegahan, Dan Pemberantasan DBD.
- [4] Alfianti, Yati. (2008). *Focus Group Discussion* (Diskusi Kelompok Terfokus) Sebagai Metode Pengumpulan
- [5] Budi Raharjo, 2012. Belajar otodidak membuat database menggunakan *MySQL*. Informatika. Bandung.
- [6] Departemen Kesehatan RI. (2003). Keputusan Menteri Kesehatan Republik Indonesia Nomor 1479/Menkes/SK/X/2003 Tentang Pedoman Penyelenggaraan Sistem Surveilans Epidemiologi Penyakit Menular dan Penyakit Tidak Menular Terpadu, 32(1), 54–55. <http://doi.org/10.1024/0301-1526.32.1.54>
- [7] Depkes RI. 2010. Profil Kesehatan Indonesia 2009. Jakarta
- [8] Dzariyatil, M. (2014). Analisis Klasifikasi Penyakit Saluran Pernafasan Akut Terhadap Tingkat Kesembuhan Pasien Berdasarkan Berkas Rekam Medis Rawat Jalan di Puskesmas Ambulu

Acknowledgments

Our thank goes to Department of Agricultural Engineering, Politeknik Negeri Jember, who has helped support for this research.

ORIGINALITY REPORT

19%

SIMILARITY INDEX

15%

INTERNET SOURCES

11%

PUBLICATIONS

10%

STUDENT PAPERS

MATCH ALL SOURCES (ONLY SELECTED SOURCE PRINTED)

7%

★ Submitted to Universitas Negeri Surabaya The
State University of Surabaya

Student Paper

Exclude quotes On

Exclude matches Off

Exclude bibliography On